

SPXTIN2199-01: 5 1/2" Mast for Davit Arm 96"

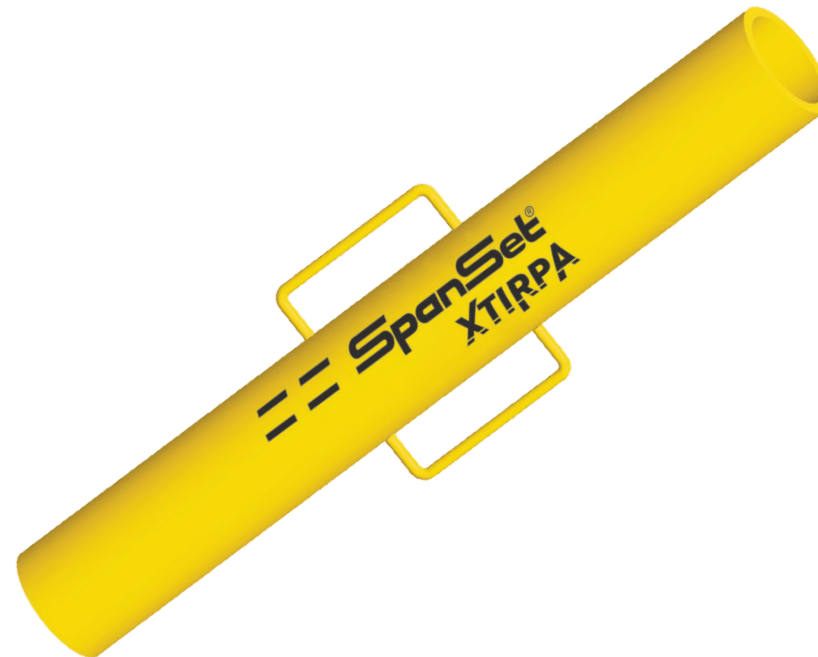

SpanSet Australia Ltd

13 Pullman Place
Emu Plains
NSW 2750
Australia

Telephone

+61 2 4735 3955

Fax

+61 2 4735 3630

E-mail

sales@spanset.com.au

Internet

www.spanset.com.au

Product number: SPXTIN2199

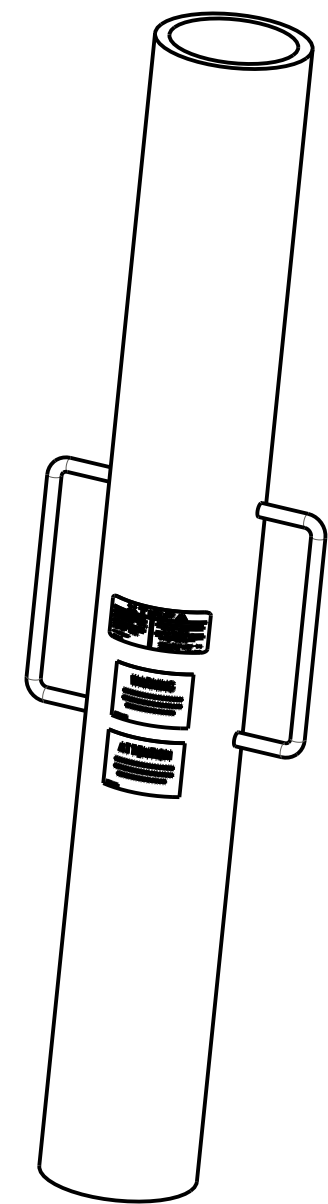
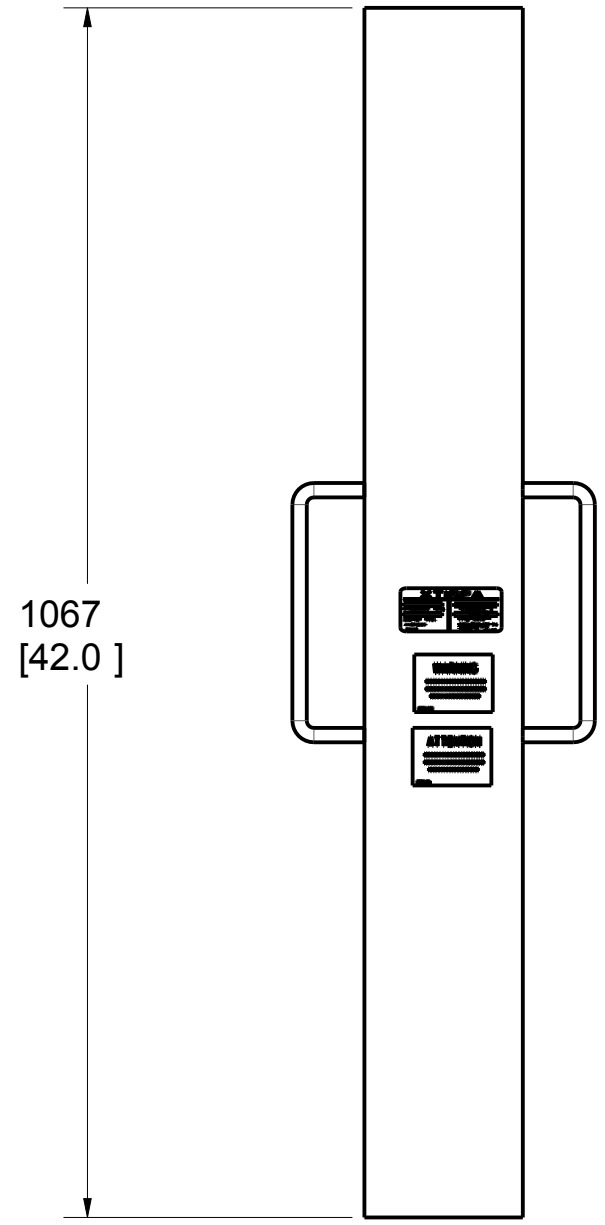
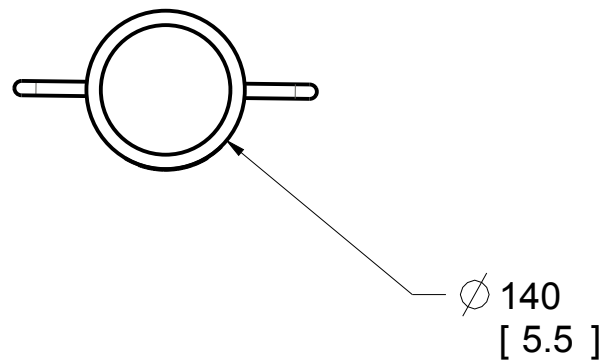

PAT. NO.:		©09/04/2010	©
PRODUITS DE SERVICE PUBLICS INNOVA INC. INNOVA PUBLIC UTILITY PRODUCTS INC.			
<small>© 9105-0732 QUEBEC INC. and under exclusive license to INNOVA PUBLIC UTILITY PRODUCTS INC., (hereafter « INNOVA »). All rights reserved. Protected under the Copyright Act of Canada and international treaties and agreements regarding copyrights. Violators are subject to prosecution and other legal recourses for infringement. Any reproduction, adaptation or other use or disclosure whatsoever, in totality or in part, and in any form or by any means whatsoever, strictly forbidden and requires the prior written approval of INNOVA. All data is the exclusive property of 9105-0732 QUEBEC INC. and under exclusive license to INNOVA and cannot be used nor disclosed in any way either without the prior written approval of INNOVA.</small>			
WEIGHT:	TITLE:		
35 Lbs	5-1/2" Mast for Davit-Arm 96"		
16 Kg			
COLOR:	MATERIAL:	SHEET(S):	PROJECT:
Yellow security	Aluminum	1 / 4	SPXTIN2199

8

7

6

5

4

3

2

1

Product number: SPXTIN2199

H
G
F
E
D
C
B
A

H
G
F
E
D
C
B
A

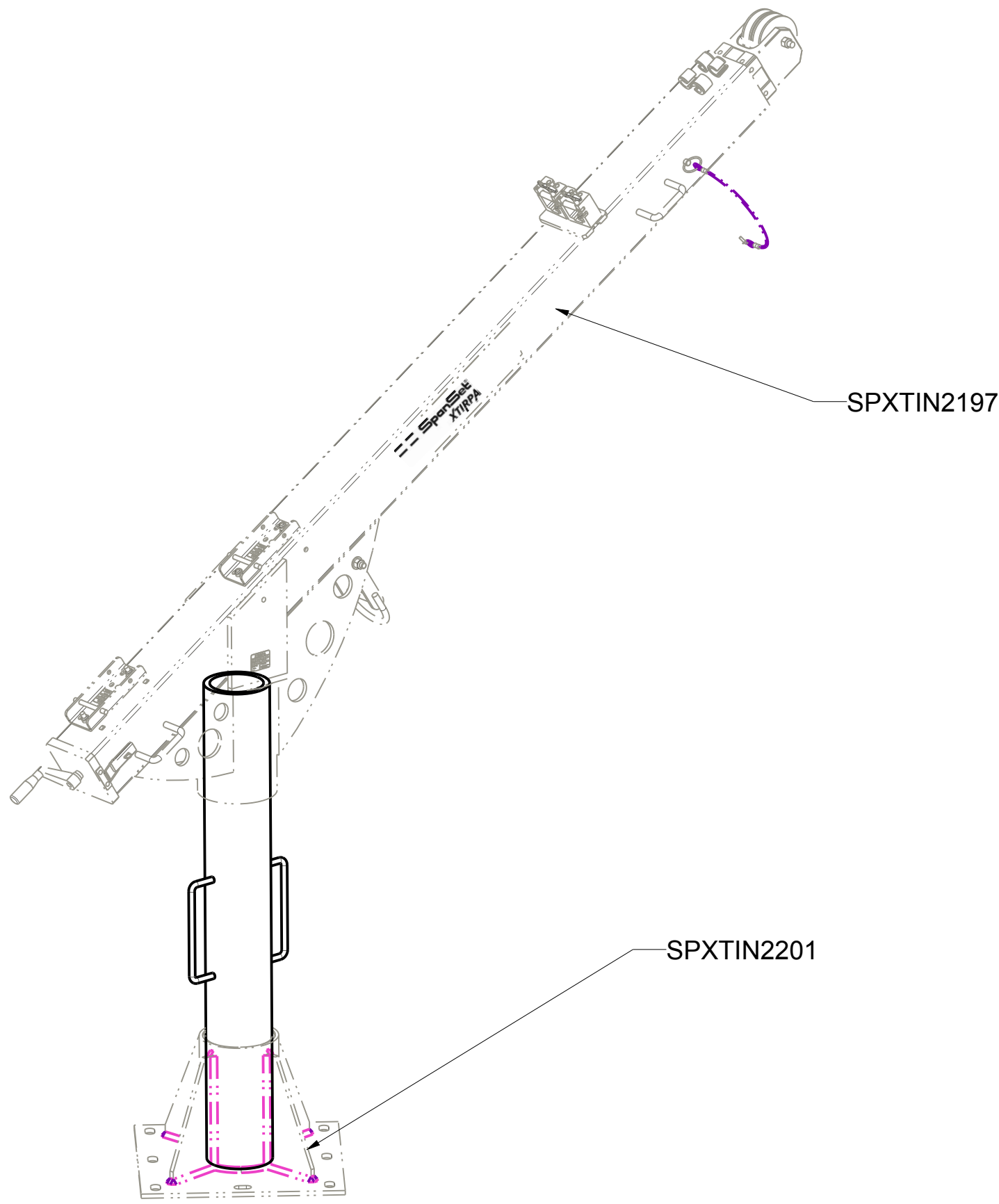

PAT. NO.:		©09/04/2010	©
PRODUITS DE SERVICE PUBLICS INNOVA INC. INNOVA PUBLIC UTILITY PRODUCTS INC.			
<small>© 9105-0732 QUEBEC INC. and under exclusive license to INNOVA PUBLIC UTILITY PRODUCTS INC., (hereafter « INNOVA »). All rights reserved. Protected under the Copyright Act of Canada and international treaties and agreements regarding copyrights. Violators are subject to prosecution and other legal recourses for infringement. Any reproduction, adaptation or other use or disclosure whatsoever, in totality or in part, and in any form or by any means whatsoever, strictly forbidden and requires the prior written approval of INNOVA. All data is the exclusive property of 9105-0732 QUEBEC INC. and under exclusive license to INNOVA and cannot be used nor disclosed in any way either without the prior written approval of INNOVA.</small>			
WEIGHT:	TITLE:		
35 Lbs	Mast 5-1/2" for Davit-Arm 96"		
16 Kg			
COLOR:	MATERIAL:	SHEET(S):	PROJECT:
Yellow security	Aluminum	2 / 4	SPXTIN2199

8

7

6

5

4

3

2

1

SPECIFICATIONS

Max Working load (mass):
 With Davit-Arm SPXTIN2197: 164 kg (360 lbs)
 Max working moment with Davit-Arm SPXTIN2197: 3905 Nm (34560 lb-in)

Max design capacity: with Davit-Arm SPXTIN2197: 16014 N (3600 lbf)
 Max design moment with Davit-Arm SPXTIN2197: 39048 Nm (345600 lb-in)

STANDARDS

Meets the following standards:
 OSHA Personal fall arrest system - 1910.66 App C
 ANSI Safety requirements for personal fall arrest system,
 subsystems and components Z359.1 (R1999)
 CAN/CSA Fall arresters, vertical lifelines, and rails Z259.2.1-98

MATERIAL AND CONSTRUCTION

Mast : Aluminum 6061-T6
 Handle : Aluminum 6061-T6
 Finish : Yellow security powder paint with metal protection base.
 Welding certification: CSA W47,2M

RESTRICTIONS

This product is to be used only with products approved by Innova utility products INC.

Important:

This product is man rated and shall be used in conjunction with Fall Arrest Equipment which limits the maximum arrest force (MAF).

Product number: SPXTIN2199

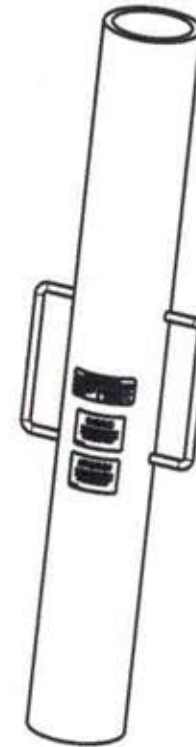

Stamping space

PAT. NO.:		009/04/2010 0	
PRODUITS DE SERVICE PUBLICS INNOVA INC. INNOVA PUBLIC UTILITY PRODUCTS INC.			
<small>© 2009-2010 INNOVA INC. and under exclusive license to INNOVA PUBLIC UTILITY PRODUCTS INC. Invention of INNOVA INC. All rights reserved. Protected under the Copyright Act of Canada and international treaties and agreements regarding copyright. This notice and subject to protection and other legal provisions for infringement, any reproduction, adaptation or other use or disclosure, in whole or in part, and in any form or by any means whatsoever, strictly forbidden and requires the prior written approval of INNOVA. All data is the exclusive property of INNOVA and requires the prior written approval of INNOVA. All data is the exclusive property of INNOVA and requires the prior written approval of INNOVA. All data is the exclusive property of INNOVA and requires the prior written approval of INNOVA.</small>			
WEIGHT:		TITLE:	
35 Lbs		5-1/2" Mast for Davit-Arm 96"	
16 Kg			
COLOR:	MATERIAL:	SHEET(S):	PROJECT:
Yellow security	Aluminum	3 / 4	SPXTIN2199

8

7

6

5

4

3

2

1

H

G

F

E

D

C

B

A

H

G

F

E

D

C

B

A

Product number: SPXTIN2199

4	1	S2201-002		Étiquette WARNING	
3	1	S2001-005_PLIER	RevB	Étiquette NO. produit et NO. Série	
2	1	S2201-001		Étiquette Attention	
1	1	SPXTA2199-01		Ass. du mat 5-1/2"	
IDX	QTE	COMPOSANTE	REV	DESCRIPTION	MATERIAU

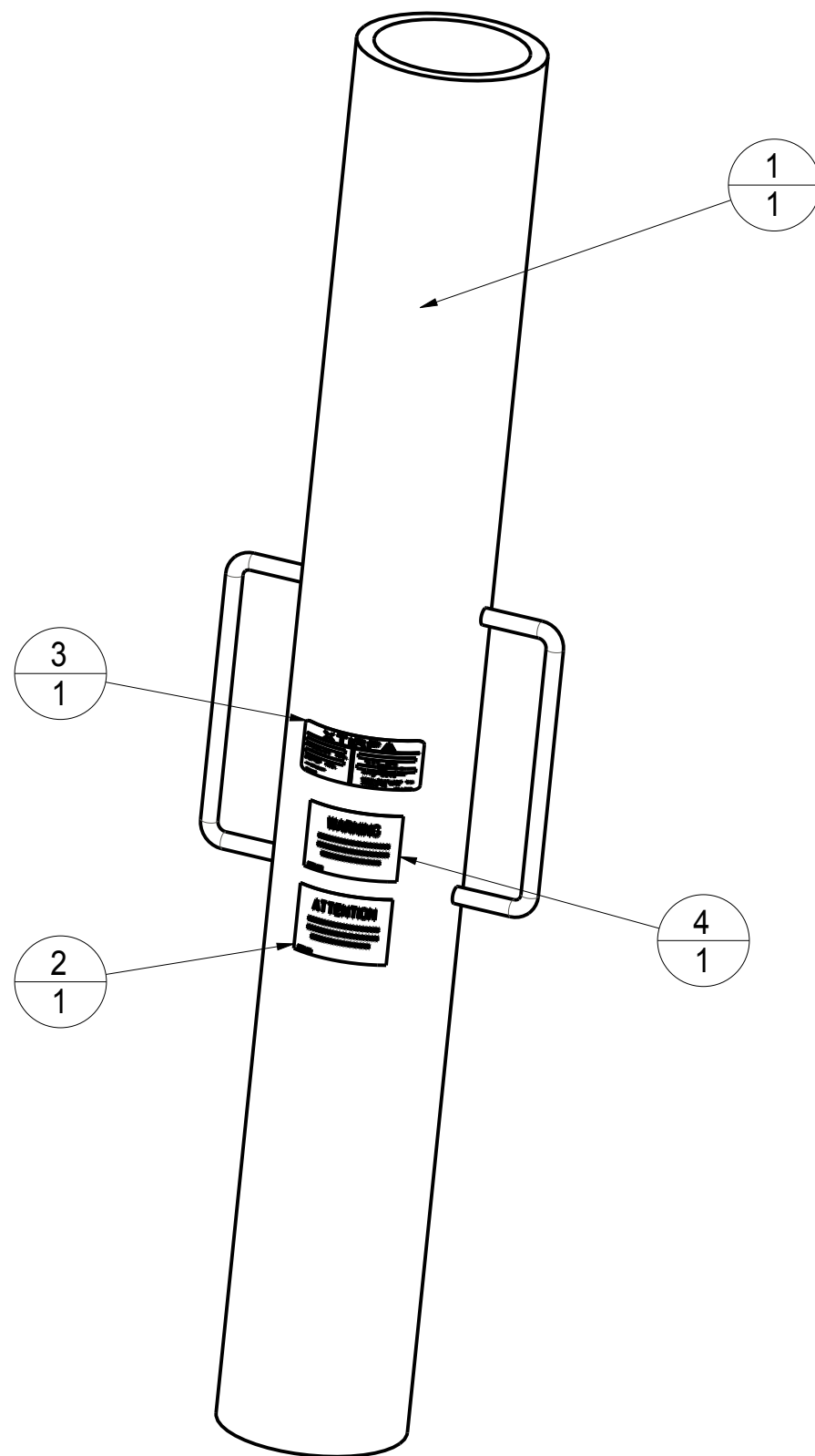

PAT. NO.:		©09/04/2010	©
PRODUITS DE SERVICE PUBLICS INNOVA INC. INNOVA PUBLIC UTILITY PRODUCTS INC.			
<small>© 9105-0732 QUEBEC INC. and under exclusive license to INNOVA PUBLIC UTILITY PRODUCTS INC., (hereafter « INNOVA »). All rights reserved. Protected under the Copyright Act of Canada and international treaties and agreements regarding copyrights. Violators are subject to prosecution and other legal recourses for infringement. Any reproduction, adaptation or other use or disclosure whatsoever, in totality or in part, and in any form or by any means whatsoever, strictly forbidden and requires the prior written approval of INNOVA. All data is the exclusive property of 9105-0732 QUEBEC INC. and under exclusive license to INNOVA and cannot be used nor disclosed in any way either without the prior written approval of INNOVA.</small>			
WEIGHT:	TITLE:		
35 Lbs	5-1/2" Mast for Davit-Arm 96"		
16 Kg			
COLOR:	MATERIAL:	SHEET(S):	PROJECT:
Yellow security	Aluminum	4 / 4	SPXTIN2199

8

7

6

5

4

3

2

1