

Suitable for:

- Flatbed Vehicle Transporters
- Vehicle Recovery Operations
- Car Dealerships and Auctions
- Motorsport and Classic Car Transport



Designed for professional use on flatbeds, trailers, and recovery trucks, our straps ensure compliance

**SpanSet Australia Ltd**

150 Old Bathurst Road  
Emu Plains NSW 2750  
Australia

**Telephone**

+61 2 4735 3955

**Email**

sales@spanset.com.au

**Internet**

www.spanset.com.au

– **TLS-C-0x2.85-0.3**

CarFix 50

Tyre Lashing System

– **TLS-C-RS-0x2.85**



Claw Replacement Strap

# TLS-C-0x2.85-0.3 - CarFix50

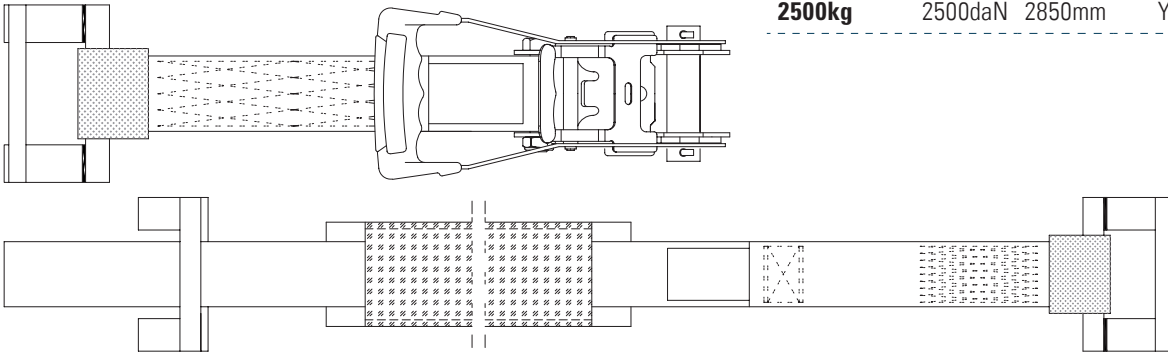
Capacity	daN	Webbing Length	TFI	JCLAW
2500kg	2500daN	2850mm	Yes	3

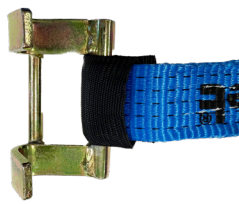

## TLS-C-0x2.85-0.3 - CarFix50

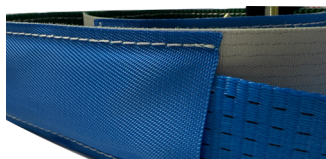
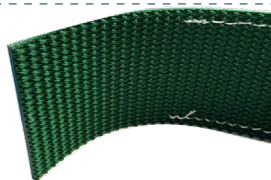
Name	Features	Appearance
<b>50mm Ratchet Buckle</b>	<ul style="list-style-type: none"> <li>– Push-up action for tensioning</li> <li>– Gold passive coating</li> <li>– Controlled release allowing pretension force to be released in small steps</li> <li>– Tension Force Indicator (TFI)</li> </ul>	
<b>End Fitting J-Claws</b>	<ul style="list-style-type: none"> <li>– 3 x double claw hook for ripple track for car carrying or tilt tray towing</li> <li>– Lashing capacity 2500kg</li> <li>– Conforms to AS/NZS 4380</li> </ul>	
<b>Tension Force Indicator</b>	<ul style="list-style-type: none"> <li>– Verify the pretension force in the system quickly and easily.</li> <li>– When the jaws of the TFI are closed, it indicates the maximum pretensioning force that can be achieved of 750 daN.</li> </ul>	
<b>50mm Webbing</b>	<ul style="list-style-type: none"> <li>– Made from high-tenacity polyester fibers, providing excellent strength, durability, and resistance to UV rays and abrasion.</li> <li>– Low stretch under load, high resistance to moisture and most chemicals</li> <li>– 2850mm length</li> </ul>	
<b>Protective Sleeve</b>	<ul style="list-style-type: none"> <li>– 80mm wide x 1100 long protective webbing sleeve</li> </ul>	
<b>Webbing Protector Grip</b>	<ul style="list-style-type: none"> <li>– Tyre sleeve provides extra positional stability and protection for the webbing strap and the tyre.</li> </ul>	

# TLS-C-RS-0x2.85 - Replacement Strap

Capacity	daN	Webbing Length	TFI	JCLAW
2500kg	2500daN	2850mm	No	1

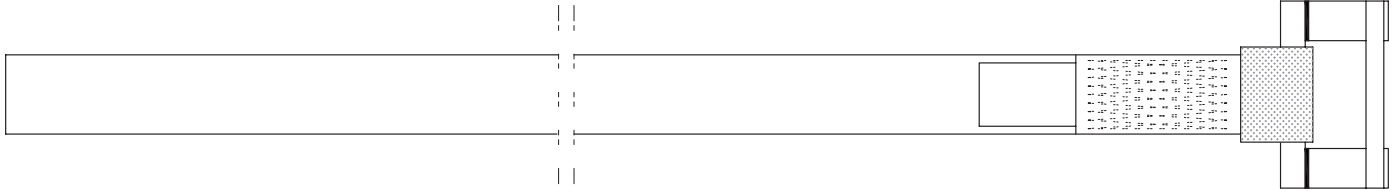

## TLS-C-RS-0x2.85 Replacement Strap

Name	Features	Appearance
<b>End Fitting J-Claws</b>	<ul style="list-style-type: none"> <li>– 1x double hook for ripple track for car carrying or tilt tray towing</li> <li>– Lashing capacity 2500kg</li> <li>– Conforms to AS/NZS 4380</li> </ul>	
<b>50mm Webbing</b>	<ul style="list-style-type: none"> <li>– Made from high-tenacity polyester fibers, providing excellent strength, durability, and resistance to UV rays and abrasion.</li> <li>– Low stretch under load, high resistance to moisture and most chemicals</li> <li>– 2850mm length</li> </ul>	